

# 5718

FINISHES:



CHROME



BRUSH NICKEL

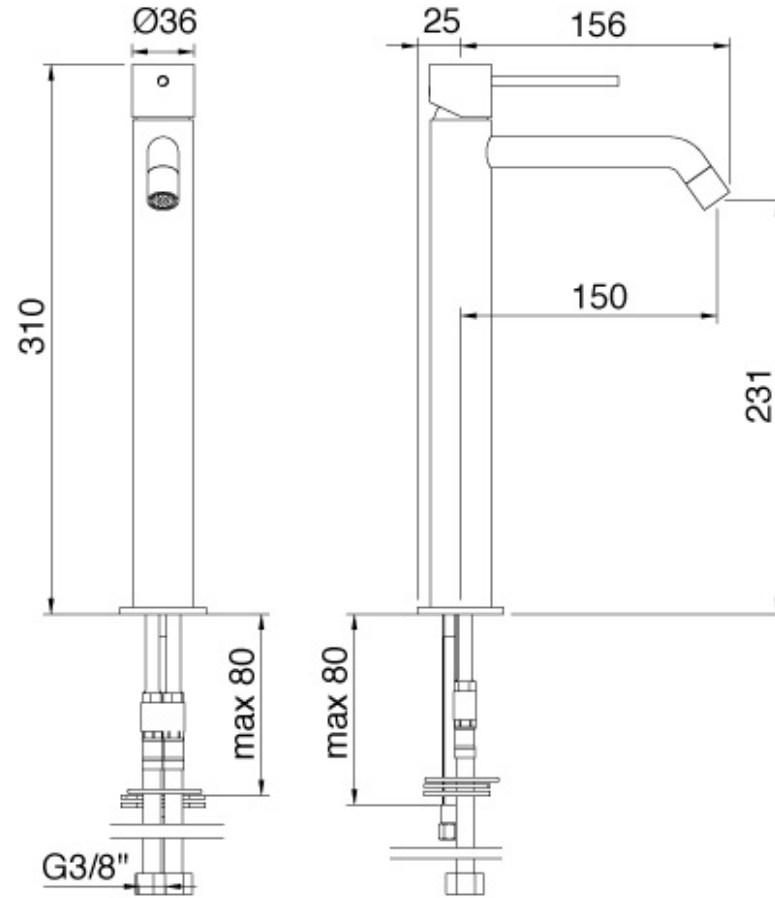

RUBINETTERIE  
**tremme**  
*instruments for water*